

KEURIG®

K•Duo®

Use & Care Guide

Get the most from your
new Keurig® brewer

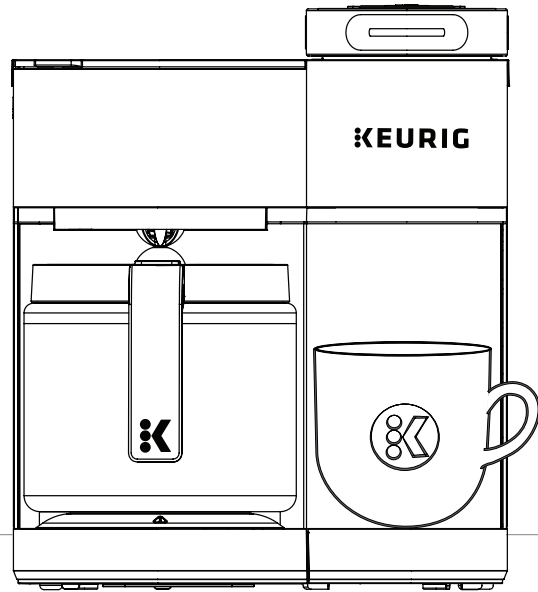

Before You Brew

1 Plug & Place

Remove packing tape from brewer and plug into an outlet.

Single Cup - Place a large mug (12oz minimum) on the drip tray.

Carafe - Rinse the carafe and place it on the heating plate.

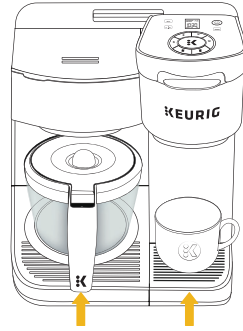

2 Rinse & Fill

Remove the water reservoir lid, then lift the reservoir straight up to remove it.

If you have a Keurig® Water Filter, install it now. Refer to your Water Filter Starter Kit for instructions.

Fill the reservoir with fresh water to the **MAX** fill line.

Replace water reservoir, making sure the lock tabs engage with the brewer.

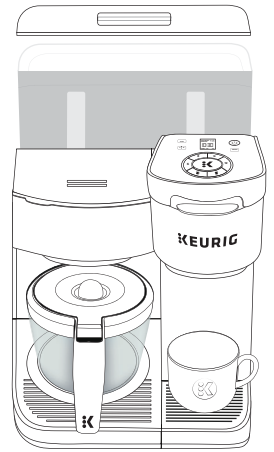

3 Power On & Set Clock

Press the **POWER** button. Use the **H/M** buttons to set the clock, then press the blinking **BREW** button to confirm the time.

NOTE: The clock must be set in order to use the Auto Brew functionality.

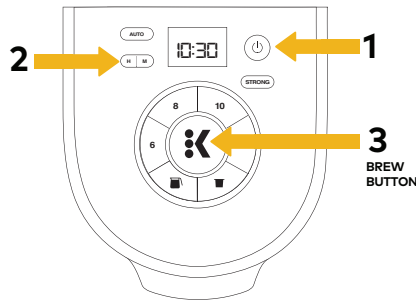

4 Cleansing Brew - Single Cup

Press the **POD** button - the 4 brew size buttons will blink. **Do not insert a K-Cup® pod.** Press the **8** button - the brew indicator light will blink. Press the **BREW** button to start the cleansing brew.

The cleansing brew will begin once the brewer is heated. The initial heating process will take about 4 minutes. The brew indicator light will pulse slowly on and off while the brewer is heating, and the light will turn solid once the brew begins.

The brew is complete when the brew indicator light is no longer illuminated. Pour the hot water into the sink.

NOTE: Between brew cycles, the brewer may take about a minute to reheat

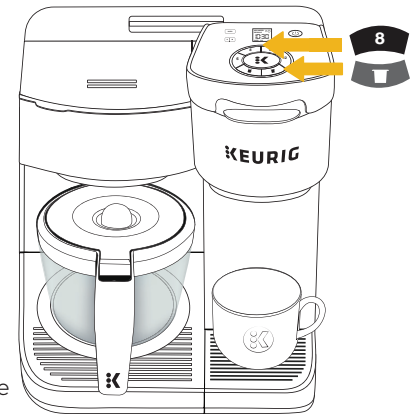

5 Cleansing Brew - Carafe

Do not fill the filter basket with coffee grounds. Press the **CARAFE** button - the 4 brew size buttons will blink, press the **8** button. The brew indicator light will blink. Press the **BREW** button to start the cleansing brew.



The **CARAFE** button will illuminate red to indicate the heating plate is on when the cleansing brew is complete. Press and hold the **CARAFE** button to turn the heating plate off, and pour the hot water into the sink.

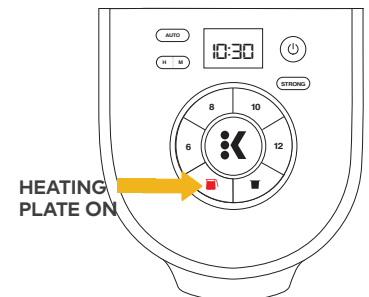

Brew Your First Single Cup

1 Place Mug & Pod

Place a mug on the drip tray. If using a travel mug, remove the drip tray and place the mug on the drip tray base. Lift the handle and place a K-Cup® pod in the K-Cup® pod holder. Lower the handle completely to close the lid.

High Altitude Brewing: While holding the brewer handle up, push down slowly on the K-Cup® pod in the pod holder until the bottom of the K-Cup® pod is punctured by the exit needle.

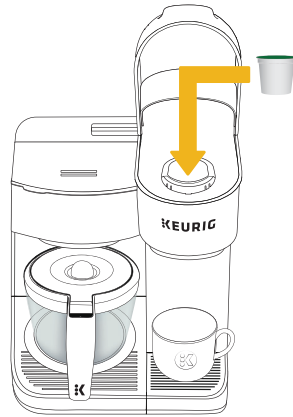

2 Brew & Enjoy!

Press the **POWER** button. The **POD** and **CARAFE** buttons will blink. Select **POD**, then select your brew size. Press the **BREW** button to initiate brewing. For a bolder coffee, press the **STRONG** button before pressing the **BREW** button.

Brewing is complete when the brew indicator light is no longer illuminated.

We recommend using a Keurig® Rinse Pod or running a cleansing brew immediately after brewing hot cocoa or other sweetened pods to keep the needles clean.

NOTE: After 5 minutes, the brewer will go into Auto Off mode. To reactivate, press the **POWER** button.

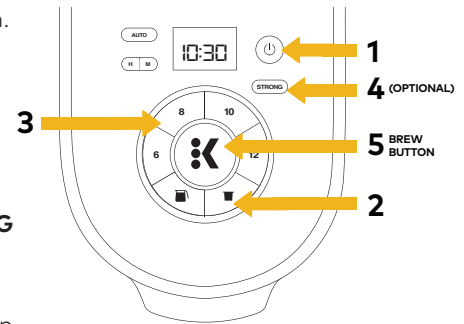

Brew Your First Carafe

1 Place Carafe & Fill Basket

Fill the water reservoir to the **MAX** fill line. Lift the filter basket cover up and insert a 12 cup paper filter into the filter basket. Add the desired amount of ground coffee (1 tablespoon of ground coffee per cup is recommended). Close the filter basket cover completely and make sure the carafe is on the heating plate.

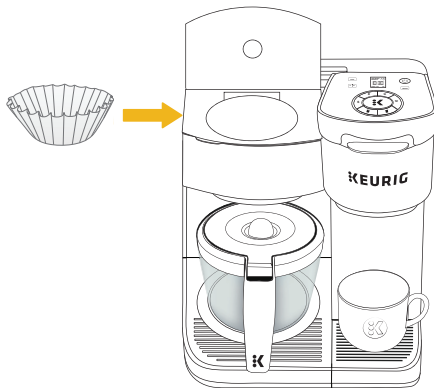

NOTE: The maximum capacity for regular ground coffee is 15 tablespoons and 12 tablespoons for decaf. Exceeding this amount may cause overflow.

2 Brew & Enjoy!

Press the **POWER** button. The **POD** and **CARAFE** buttons will blink. Select **CARAFE**, then select your brew size. Press the **BREW** button to initiate brewing.

Once the brew is complete, the heating plate will automatically turn on and remain on for 2 hours - the **CARAFE** button will illuminate red. To turn off the heating plate, press and hold the **CARAFE** button until the light is no longer illuminated.

If you accidentally shut the heating plate off, press and hold the **CARAFE** button until the red light illuminates to turn it back on.

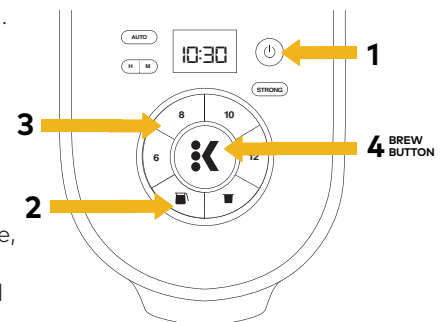

Brewer Features

Smart Start heats then brews in one simple process. No need to wait for the brewer to heat before selecting brew size. Power on your brewer, add coffee, select your brew type, then select your brew size. Press the **BREW** button. The brewer will heat, then automatically begin brewing.

Single Cup Auto Off automatically turns your brewer off 5 minutes after the last brew for energy savings.

Carafe Auto Off automatically turns your heating plate off 2 hours after the last brew for energy savings.

Auto Brew programs the carafe to brew at a specific time up to 24 hours in advance.

Strong Brew increases your coffee strength and intensity for a single cup. For bolder coffee, press the **STRONG** button.

High Altitude To ensure your brewer works properly at higher altitudes (5,000 feet), enable the High Altitude setting by pressing and holding the **POD** and **CARAFE** button for 3 seconds. When enabled, a mountain icon  will appear on the display screen.

Pause & Pour a cup mid-brew while brewing a carafe using the 20 second automatic pause feature.

NOTE: Removing the carafe for more than 20 seconds may cause the filter basket to overflow.

Auto Brew Instructions

Fill the water reservoir to **MAX** fill line and load the paper filter and coffee grounds.

1. Press the **AUTO** button. Use the **H/M** buttons to set the time for auto brew to begin, press the blinking **BREW** button to confirm the time.
2. Choose your brew size, then press the blinking **BREW** button to confirm the size.

The AUTO brew setup is now complete.

A **clock icon** will appear on the screen and the **AUTO** button will be illuminated to signal AUTO is on.

Note: Once AUTO brew is enabled, you will only be able to brew a single cup. To disable AUTO brew, press the **AUTO** button once. The **clock icon** will disappear from the screen.

Caring For Your Brewer

Regular cleaning keeps your brewer running smoothly. Always be sure to turn off and unplug your brewer before cleaning. We recommend using a Keurig® Rinse Pod or running a cleansing brew immediately after brewing hot cocoa or other sweetened pods to keep the needles clean.

CAUTION: Parts are not dishwasher safe.

Brewer Exterior

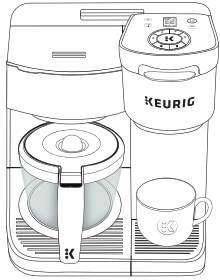

Keep your Keurig® brewer looking its best by cleaning the exterior from time to time. Just clean with a damp, soapy, lint-free, non-abrasive cloth. Never immerse the brewer in water or other liquids.

Drip Tray

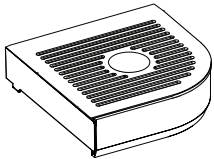

The drip tray can hold up to 8 ounces of overflow and should be emptied and cleaned occasionally. To remove, slide it toward you, keeping it level to avoid spilling. Clean with a damp, soapy, lint-free, non-abrasive cloth.

Carafe & Carafe Lid

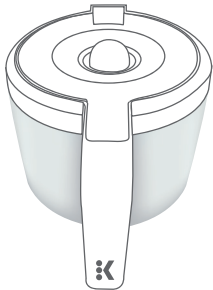

The Carafe and Carafe Lid should be cleaned after each brew. Rinse and clean with a damp, soapy, lint-free, non-abrasive cloth.

Heating Plate

Once the heating plate has cooled completely, gently wipe with a clean, damp cloth. Never use rough, abrasive materials or cleansers to clean the heating plate.

NOTE: To turn off the heating plate you can either press the **POWER** button or press and hold the **CARAFE** button until the red light is no longer illuminated.

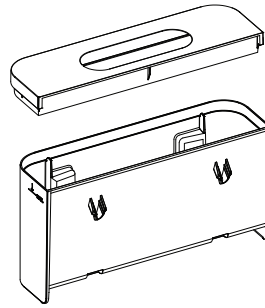

Water Reservoir & Reservoir Lid

The water reservoir lid and water reservoir should be cleaned periodically with a damp, soapy, non-abrasive cloth. Rinse the reservoir thoroughly after cleaning. This will ensure that no cleaning solutions remain in the area as they may contaminate the water supply. After rinsing, fill the reservoir with clean water and return it to the brewer. Do not dry the inside of the water reservoir with a cloth as lint may remain. The water reservoir lid and water reservoir should not be put into the dishwasher.

NOTE: If you are using a water filter inside the water reservoir, remove it before cleaning. The filter cartridge should be replaced regularly as needed per filter instructions.

Filter Basket

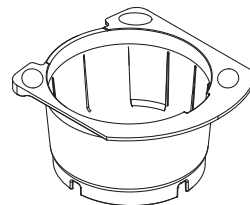

Remove the filter basket from the brewer. Remove and discard the paper filter and ground coffee. The filter basket should be washed in warm, soapy water and rinsed thoroughly. Dry all parts after use.

NOTE: Coffee grounds should be discarded and the filter basket should be rinsed clean after brewing, or in part with the daily cleaning routine.

Caring For Your Brewer (continued)

K-Cup® Pod Holder

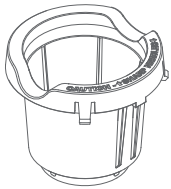

To remove the K-Cup® pod holder from the brewer, lift the handle and grasp the top of the K-Cup® pod holder with one hand while pushing up on the bottom of the K-Cup® pod holder from underneath with the other until it releases. After cleaning, align the K-Cup® pod holder with the opening using the two front ribs as a guide and snap into place from the top.

CAUTION: There are sharp needles that puncture the K-Cup® pod above the K-Cup® pod holder and in the bottom of the K-Cup® pod holder. To avoid risk of injury, do not put your fingers in the K-Cup® pod holder.

NOTE: Used K-Cup® pod should be removed from the K-Cup® pod holder after brewing, or in part with the daily cleaning routine.

Funnel

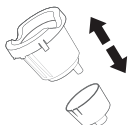

The funnel can be removed from the K-Cup® pod holder by pulling on it until it pops off. To replace it, orient the snaps to the indent and just snap it back onto the K-Cup® pod holder.

Exit Needle

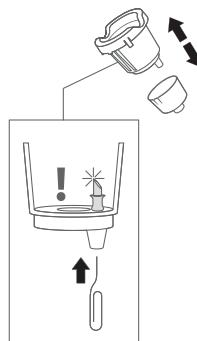

Remove the pod holder assembly and detach the funnel. Locate the exit needle on the inside bottom of the K-Cup® pod holder. Insert a straightened paper clip into the exit needle to loosen any coffee grounds.

Entrance Needle

Lift the brewer handle and locate the entrance needle on the underside of the lid. To clean all three holes in the needle, hold the brewer handle in the upward position and with your other hand, carefully insert a straightened paper clip into all three holes. Gently move it around to loosen any coffee grounds. Lower the handle completely and run two water-only brew cycles. Do not insert a K-Cup® pod.

TIP: Refer to support.keurig.com for video instructions on cleaning the entrance/exit needles.

Descaling your Brewer

As part of your preventative maintenance routine, you should descale your brewer every 3 months (or if you experience low coffee volume or slower performance). Properly follow the descaling procedure.

Depending on the mineral content of your water, calcium deposits or scale may build up in your brewer. Scale is non-toxic but if left unattended can hinder brewer performance. Regularly descaling your brewer every 3 months helps maintain the heating element, and other internal parts that come in contact with water. Calcium deposits may build up faster, making it necessary to descale more often.

Descaling Procedure

Before you begin, you will need a large ceramic mug, fresh water, Keurig® Descaling Solution, and access to a sink. Do not use a paper cup. Ensure that there is no beverage pod in the K-Cup® pod holder. Please allow approximately 75 minutes for the descaling procedure.

Empty the water from the water reservoir. If using a Keurig® Water Filter, remove and set aside.

STEP 1: Descaling Solution Rinse

Power the brewer off.

Pour the entire bottle of Keurig® Descaling Solution into an emptied water reservoir. Then, fill the empty bottle with water and pour into the water reservoir. **Do not add any K-Cup® pods or ground coffee.**

Place a large mug on the drip tray, then press the **POWER** button. Select **POD**, then press the **12** button. Press the **BREW** button to start a single cup rinse brew. Pour the hot liquid into the sink.

Make sure the carafe is on the heating plate. Press the

CARAFE Button, then select the **12** button and press the **BREW** button to start a carafe rinse brew. When the brew is complete, pour the hot liquid into the sink. Press the **POWER** button to turn the heating plate off.

STEP 2: Rinse & Rest

Let brewer stand for at least 30 minutes.

After 30 minutes, discard any residual solution from the water reservoir and rinse thoroughly.

STEP 3: Fresh Water Rinse

Fill the water reservoir with fresh water to the **MAX** fill line.

Make sure the carafe is on the heating plate. Press the **POWER** button and select **CARAFE**. Then press the **12** button and press the **BREW** button to start a carafe water brew. When the brew is complete, press and hold the **CARAFE** button to turn off the heating plate. Pour the hot liquid into the sink.

Fill the water reservoir to the **MAX** fill line. Repeat the 12-cup carafe rinse 3 more times for a total of 4 brews.

Refill the water reservoir and place a large mug on the drip tray. Press the **POWER** button. Select **POD**, then press the **12** button. Press the **BREW** button to start a single cup water brew. Pour the hot liquid into the sink.

Repeat the 12 oz brew process three more times for a total of 4 brews.

NOTE: The cleaning action of Keurig® Descaling Solution may result in a "foam" dispensed from the brewer. This is natural, as the solution is reacting with the scale inside. For a brewer that is heavily scaled, the brewer may not fill properly after the descaler is added. If this occurs, you may see only a small or no output dispensed, followed by the sound of air blowing out. If this occurs:

- Turn off and unplug the brewer.
- If there is Keurig® Descaling Solution in the water reservoir, discard the contents, rinse the water reservoir thoroughly and refill with water.
- Plug the brewer back in, power on, and repeat the Step 3 Fresh Water Rinse cycle. The brewer should begin to function normally as the solution is rinsed out and the scale is removed. If problem persists, allow brewer to sit unplugged for at least 30 minutes before continuing with the rinse.

Troubleshooting

Grounds in Your Coffee

Grounds may have gathered in the exit or entrance needles and can be cleaned using a straightened paper clip or similar tool.

- Clean the exit needle of the K-Cup® pod holder. Refer to the Exit Needle care instructions.
- Clean the brewer entrance needle. Refer to the Entrance Needle care instructions.
- **Carafe brewing** - The maximum capacity for regular ground coffee is 15 tablespoons and 12 tablespoons for decaf. Exceeding this amount may cause overflow.

Brewer Will Not Brew

- After placing the K-Cup® pod in the K-Cup® pod holder, make sure that the handle is pushed down securely.
- If the add water light is illuminated, add water to water reservoir. Fill to and not beyond the MAX fill line. Make sure the water reservoir is seated properly in its base. If the add water light continues to be illuminated even after refilling, contact Customer Service.
- If all of the buttons blink simultaneously, contact Customer Service.

Brewing a Partial Cup or Carafe

- Make sure there is enough water in the water reservoir to perform the selected brew size.
- The exit needle may be clogged. Refer to the Exit Needle care instructions.
- The water reservoir may have been removed during brewing. Replace the water reservoir and perform a rinsing brew without a K-Cup® pod.
- The brewer may need to be descaled. If you have repeated the descale procedure on your brewer two times and it is still only brewing a partial cup, contact Customer Service.
- The drip stop may be clogged. Remove the filter basket drawer and filter basket and rinse thoroughly to remove any grounds in the plunger.
- If you live at a high altitude and experience short carafe brews, please contact Customer Service.

Brewer Does Not Have Power or Shuts Off

- Make sure that you have pressed the **POWER** button to turn the brewer on.

- Plug brewer into its own grounded outlet. If the electric circuit is overloaded with other appliances, your brewer may not function properly. The brewer should be operated on its own circuit, separate from other appliances.
- For energy savings, your brewer is set to turn off automatically 5 minutes after your last brew.
- If the brewer still doesn't have power, contact Customer Service.

Helpful Hints

Water quality varies greatly. If you notice an undesirable taste in your beverage (such as chlorine or mineral tastes), we recommend using bottled or filtered water. Do not use distilled water. You can also install a Keurig® Water Filter to help remove water impurities and improve beverage taste.

Carafe Brewing

- The maximum capacity for regular ground coffee is 15 tablespoons and 12 tablespoons for decaf. Exceeding this amount may cause overflow.
- When inserting a paper filter to the filter basket, make sure it is properly seated flat.
- If the brewer is not used for a few days, run a full carafe rinse brew to flush out the internal water.

Service

Beyond these recommended cleaning and maintenance procedures, this brewer is not user serviceable. For service, please refer to the Warranty section of this guide.

Storage

Empty the water reservoir before storing or transporting and take care to ensure that you store your brewer in a safe and frost free environment. Please be sure to store your brewer

in its upright position to avoid water leakage from the inner tank. If you store the brewer in a cold environment, you run the risk of water freezing inside the brewer and causing damage. When you prepare to use it after storage, we recommend rinsing the water reservoir with fresh water and running three rinsing brews without a K-Cup® pod, as well as running a 12 cup carafe brew with no ground coffee.

If you plan to move your brewer to a different location, turn the brewer off, unplug it, and empty the water reservoir. If your brewer has been in an environment below freezing, please be sure to let it warm to room temperature for at least 2 hours before using.

CAUTION: Please ensure brewer is powered off and heating plate is cooled to room temperature before storing.

NOTE: If the brewer needs to be stored for an extended period of time (a few months or more), a full descaling can be conducted before and after storage to ensure the brewer is in its best condition.

Click or Call!

Have Questions?

We're here to help. Visit support.keurig.com for step-by-step videos on cleaning, descaling, and more.



Still Need Help?

Give us a call at
1-866-901-BREW (2739)

Warranty

LIMITED ONE YEAR WARRANTY

Keurig Green Mountain, Inc. (Keurig) warrants that your brewer will be free of defects in materials or workmanship under normal home use for one year from the date of purchase. It is recommended that you register your brewer on keurig.com/new so that your purchase information will be stored in our system. Keurig will, at its option, repair or replace a defective brewer without charge upon its receipt of proof of the date of purchase. If a replacement brewer is necessary to service this warranty, the replacement brewer may be new or reconditioned. If a replacement brewer is sent, a new limited one year warranty will be applied to the replacement brewer.

This warranty only applies to brewers operated in the United States and Canada. This warranty gives you specific legal rights, and you may also have other rights that vary from state to state and, in the case of Canada, from province to province.

Only the use of Keurig® K-Cup® brand pods and accessories will guarantee the proper functioning and lifetime of your Keurig® brewer. Any damage to or malfunction of your brewer resulting from the use of non-Keurig® pods and accessories may not be covered by this warranty or may result in a service fee if the damage or malfunction is determined to be caused by such use.

WHAT IS NOT COVERED BY THE LIMITED WARRANTY?

THIS WARRANTY DOES NOT COVER CONSEQUENTIAL OR INCIDENTAL DAMAGES SUCH AS PROPERTY DAMAGE AND DOES NOT COVER INCIDENTAL COSTS AND EXPENSES RESULTING FROM ANY BREACH OF THIS WARRANTY, EVEN IF FORESEEABLE. Some states or provinces do not allow the exclusion or limitations of incidental or consequential damages, so the above limitation or exclusion may not apply to you depending on the state or province of purchase.

Nor does this warranty cover damages caused by use of non-Keurig® pods or accessories, services performed by anyone other than Keurig or its authorized service providers, use of parts other than genuine Keurig® parts, or external causes such as abuse, misuse, inappropriate power supply, or acts of God.

OTHER LIMITATIONS

THIS WARRANTY IS EXCLUSIVE AND IS IN LIEU OF ANY OTHER EXPRESS WARRANTY, WHETHER WRITTEN OR ORAL. IN ADDITION, KEURIG HEREBY SPECIFICALLY DISCLAIMS ALL OTHER WARRANTIES WITH RESPECT TO YOUR K-DUO™ BREWER, INCLUDING ANY IMPLIED WARRANTY OF MERCHANTABILITY OR FITNESS FOR ANY PARTICULAR PURPOSE. Some states or provinces do not allow disclaimers of such implied warranties or limitations on how long an implied warranty lasts, so the above limitation may not apply to you depending on the state or the province of purchase.

HOW DO YOU OBTAIN WARRANTY SERVICE?

Keurig® brewers are high-quality appliances and, with proper care, are intended to provide years of satisfying performance. However, should the need arise for warranty servicing, simply call Keurig Customer Service at our toll free phone number 1.866.901.BREW (2739). Please do not return your brewer for servicing without first speaking to Keurig Customer Service to obtain a Return Materials Authorization (RMA) number. Keurig® brewers returned without an RMA number will be returned to the sender without servicing.

K-Duo® Coffee Maker

- A. Water Reservoir Lid
- B. Water Reservoir
- C. MAX Fill Line
- D. Water Reservoir Lock Tabs
- E. Power Cord
- F. Handle
- G. Filter Basket Cover
- H. K-Cup® Pod Holder (H and I are the K-Cup® Pod Holder Assembly)
- I. Funnel
- J. K-Cup® Pod Assembly Housing
- K. Drip Tray Plate
- L. Drip Tray
- M. Drip Tray Base
- N. Carafe and Lid
- O. Heating Plate
- P. Filter Basket

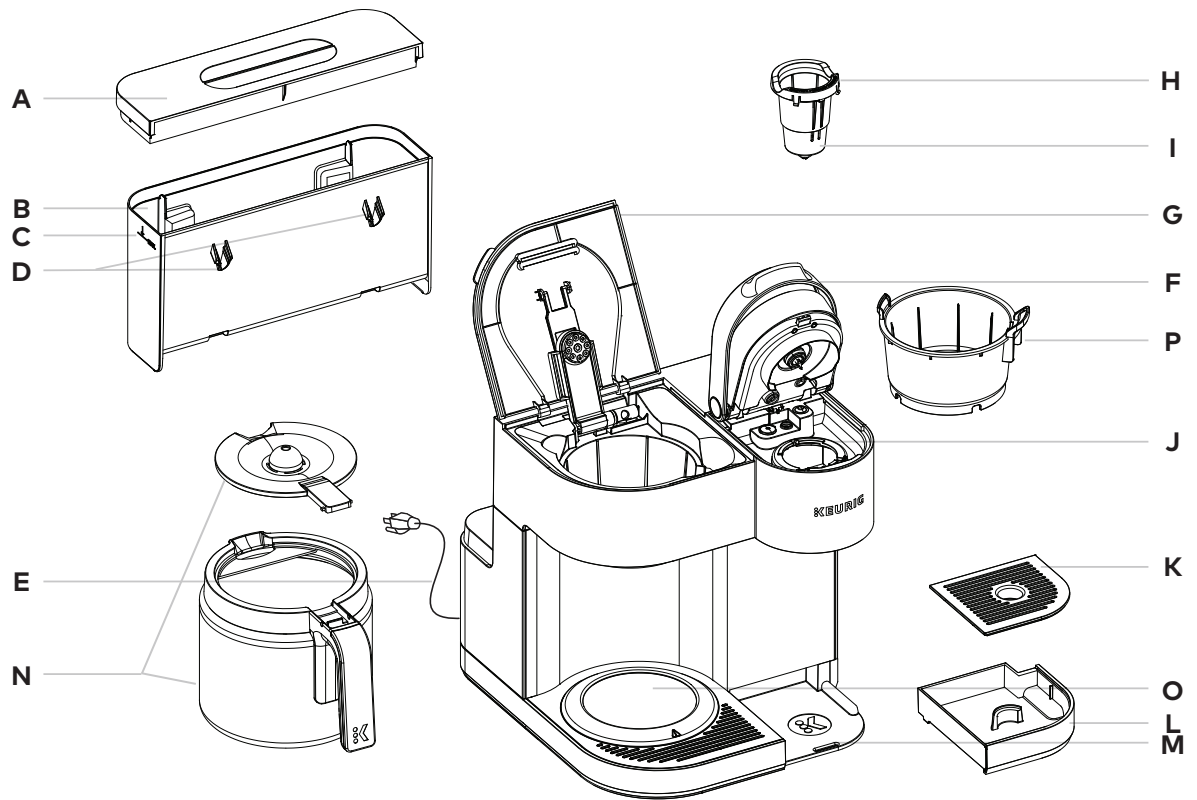

For replacement parts, please visit www.Keurig.com

Coffeehouse taste in your own home.

FIND YOUR PERFECT POD

With over 70 brands and hundreds
of varieties, find your match at

keurig.com/new